

## CATCH THE CULPRITS!

Colour in the different products on the crime scene activity sheet and cut them out. If you don't have a printer, draw them on a piece of paper instead. Can you use your detective skills to sort them into two groups, the sugar 'heroes' and the sugar 'culprits'?

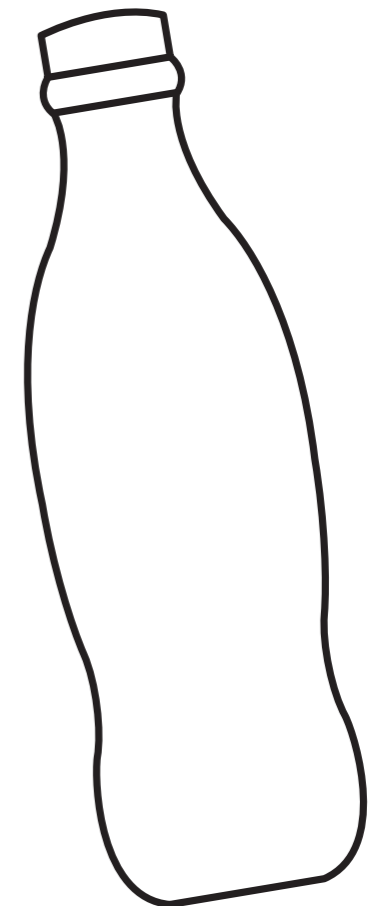
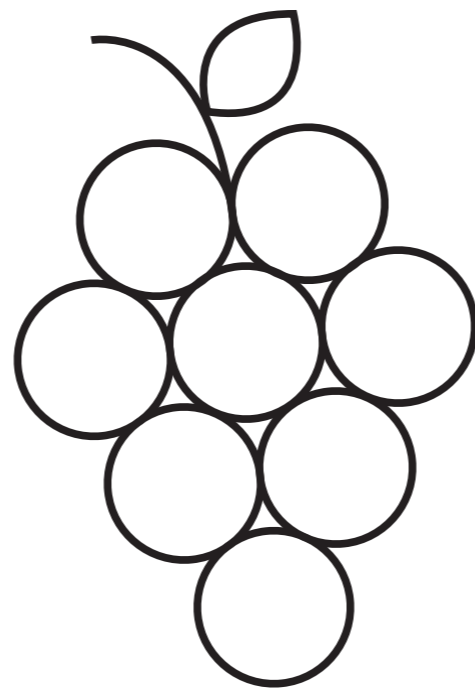
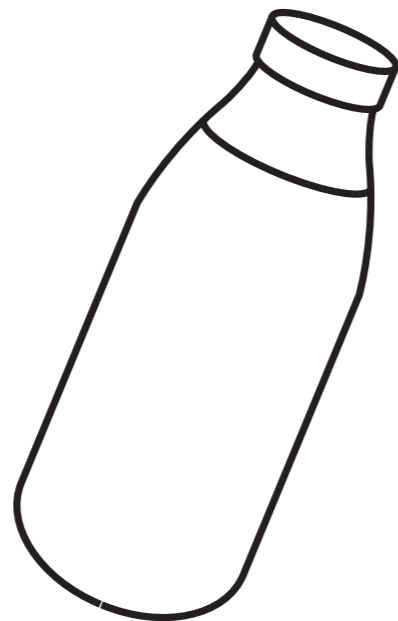
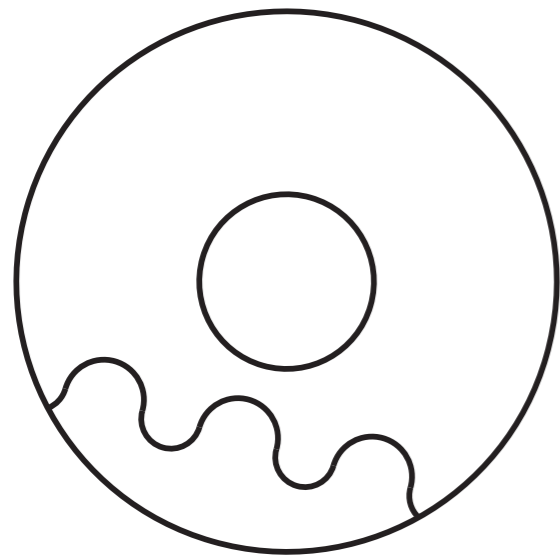
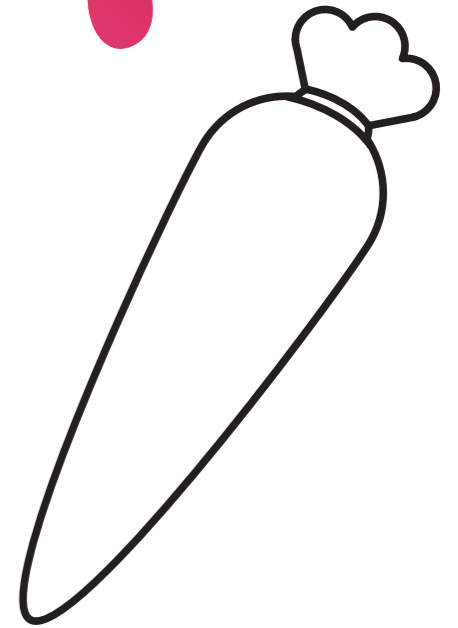
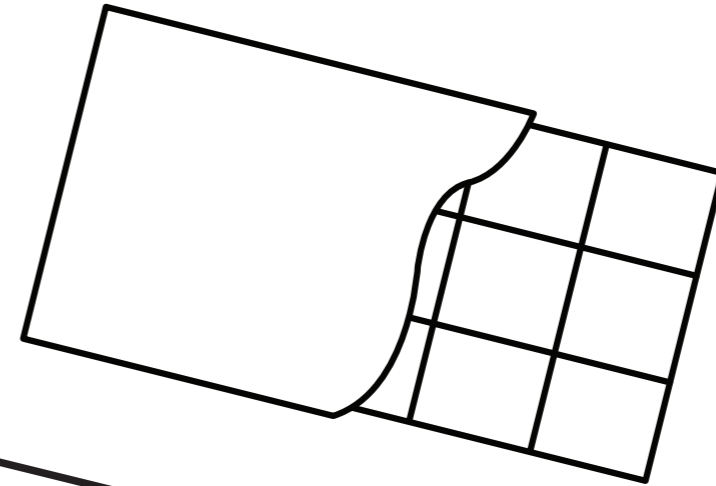
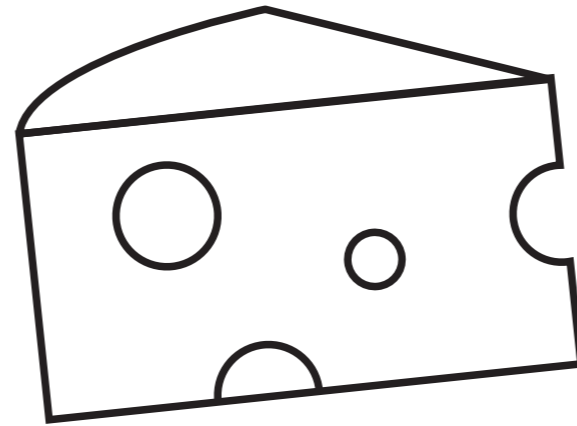
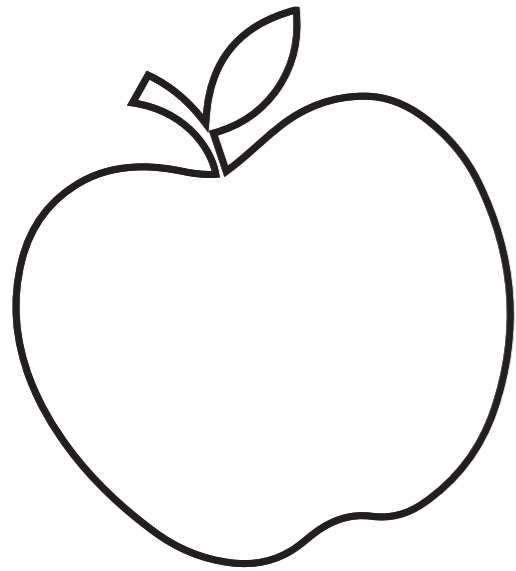

## IDENTITY PARADE

Look at the different foods and drinks – ‘sugar heroes’ and ‘sugar culprits’ – you cut out earlier. Lay them out in order of best (low sugar) to worst (high sugar) on the identity parade. If you don’t have a printer, create your own identity parade by drawing lines on a piece of paper using a pencil and a ruler.

13 TSP

12 TSP

11 TSP

10 TSP

9 TSP

8 TSP

7 TSP

6 TSP

5 TSP

4 TSP

3 TSP

2 TSP

1 TSP



## HEALTHY SUGAR SWAPS

Look at all of the food and drink items in front of you.

Which 'culprits' could be swapped with 'heroes' to make a healthier choice (where all traffic lights are green).

Write them next to each other on your worksheet. For example, you could swap cola with water. If you don't have a printer, simply write your own list on a piece of paper.



SWAP FOR



## FIND THE CULPRITS IN YOUR CUPBOARD

1. Make a list of five items in your cupboard or fridge.
2. Write down the amount of sugar they contain in grams or teaspoons (you can scan them with the Change4Life sugar smart app if your parent or guardian has a smartphone).

3. Tell us which item was a sugar hero (low sugar) and which was a sugar culprit (high sugar).
4. Make some suggestions for healthy sugar swaps.

If you don't have a printer, copy out these columns onto a piece of paper and make your own list.

Item	Sugar in grams/ no. of teaspoons	Sugar Hero or sugar culprit?	Healthy sugar swap
1.			
2.			
3.			
4.			
5.			

## DOT-TO-DOT

Connect the dots to reveal the different food or drinks. Are they a sugar hero (low sugar) or a sugar culprit (high sugar)? Colour in your finished images and write the name of each item underneath.

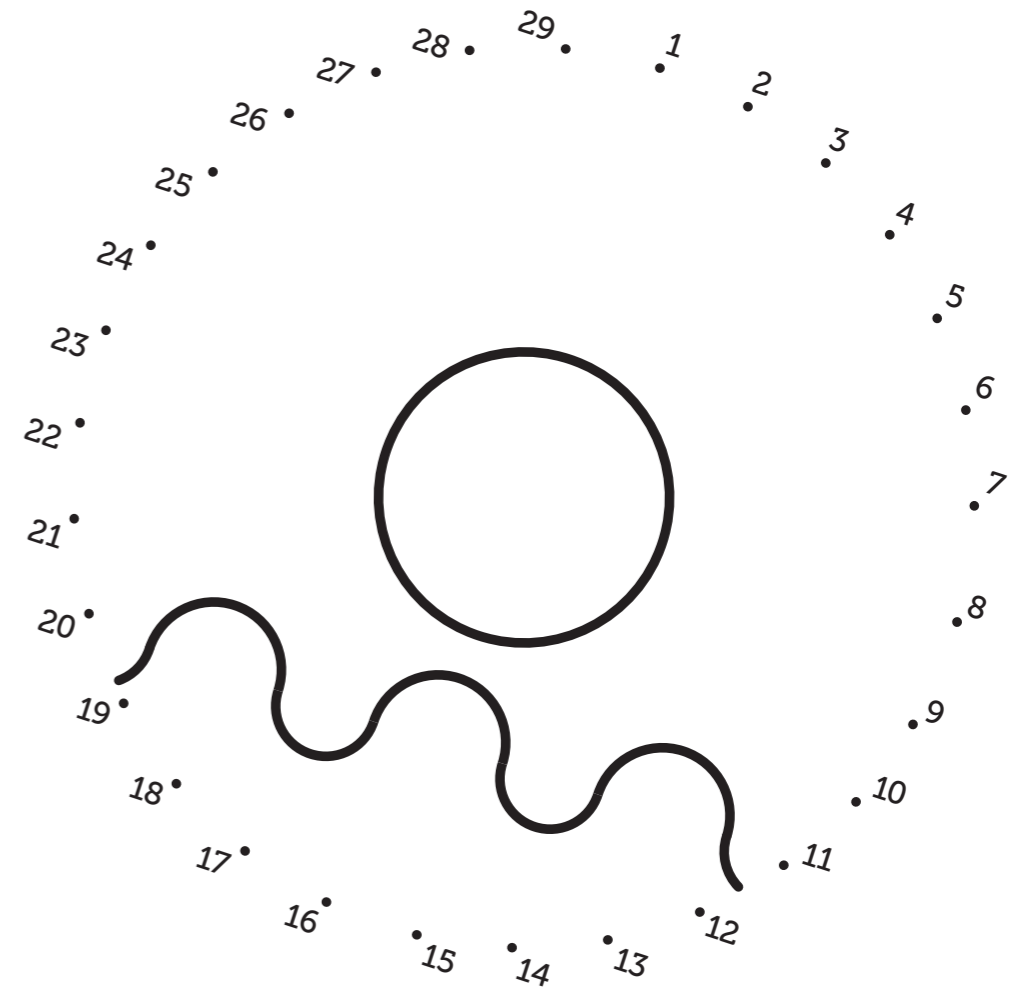
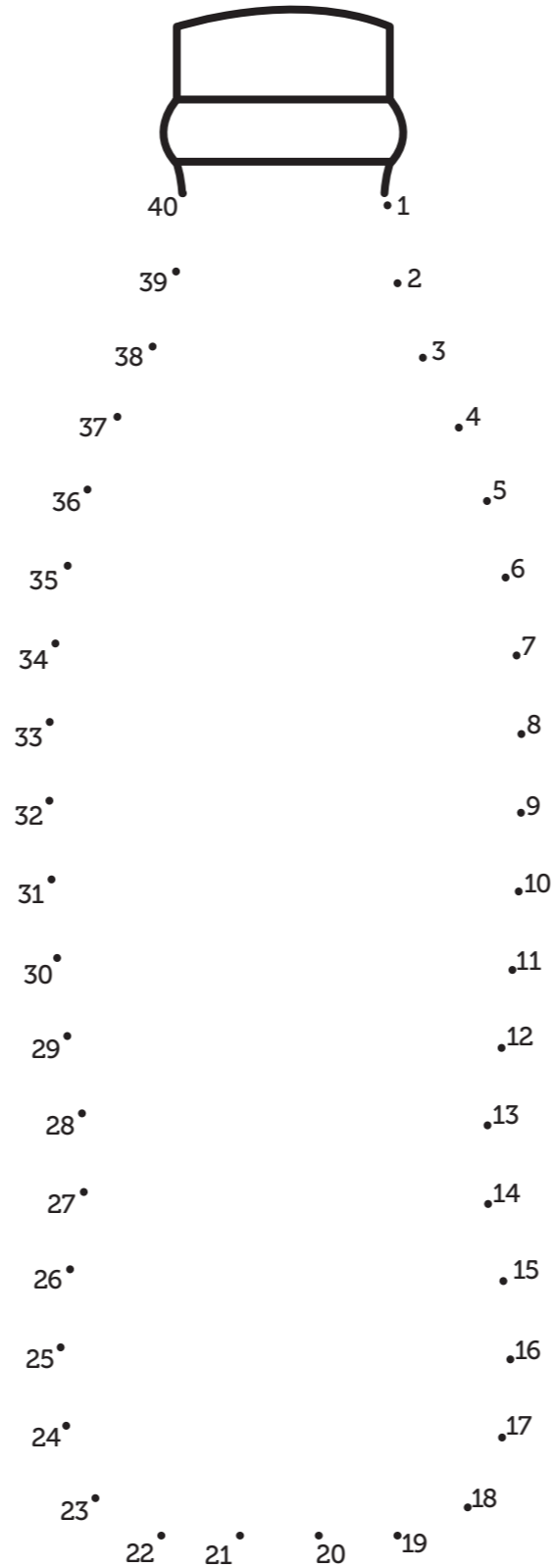
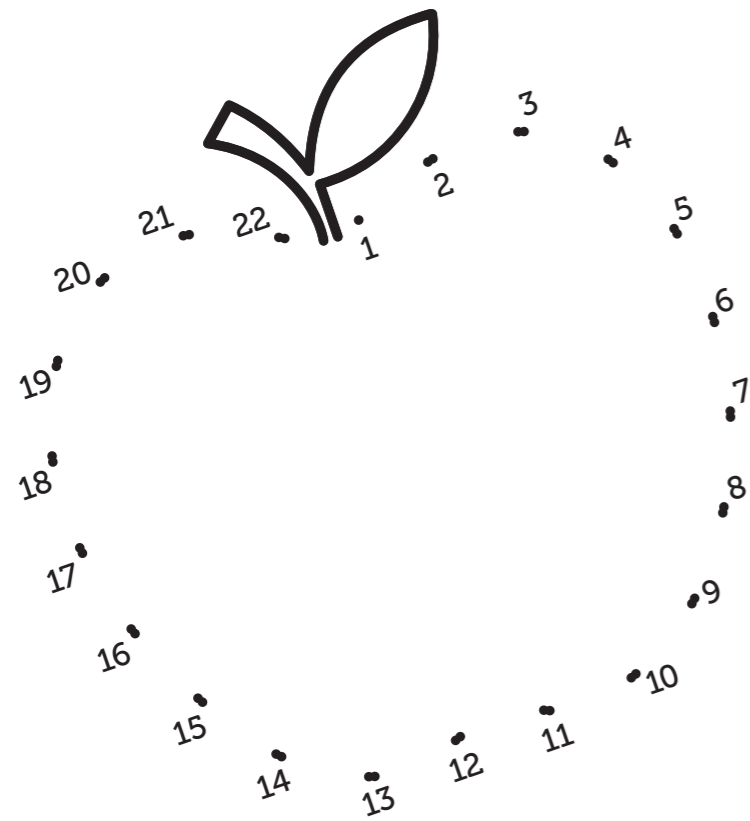

## DOT-TO-DOT

Connect the dots to reveal the different food or drinks.  
Are they a sugar hero (low sugar) or a sugar culprit (high sugar)? Colour in your finished images and write the name of each item underneath.

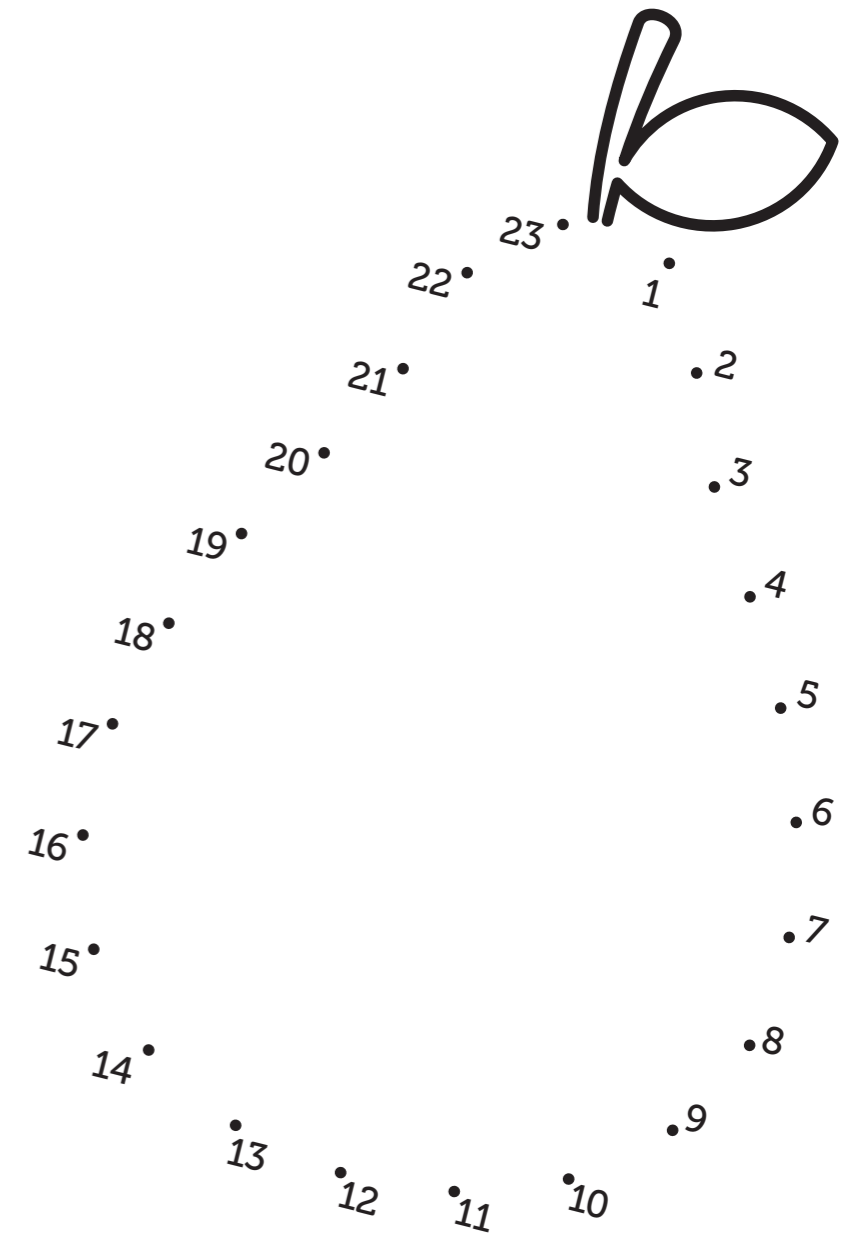
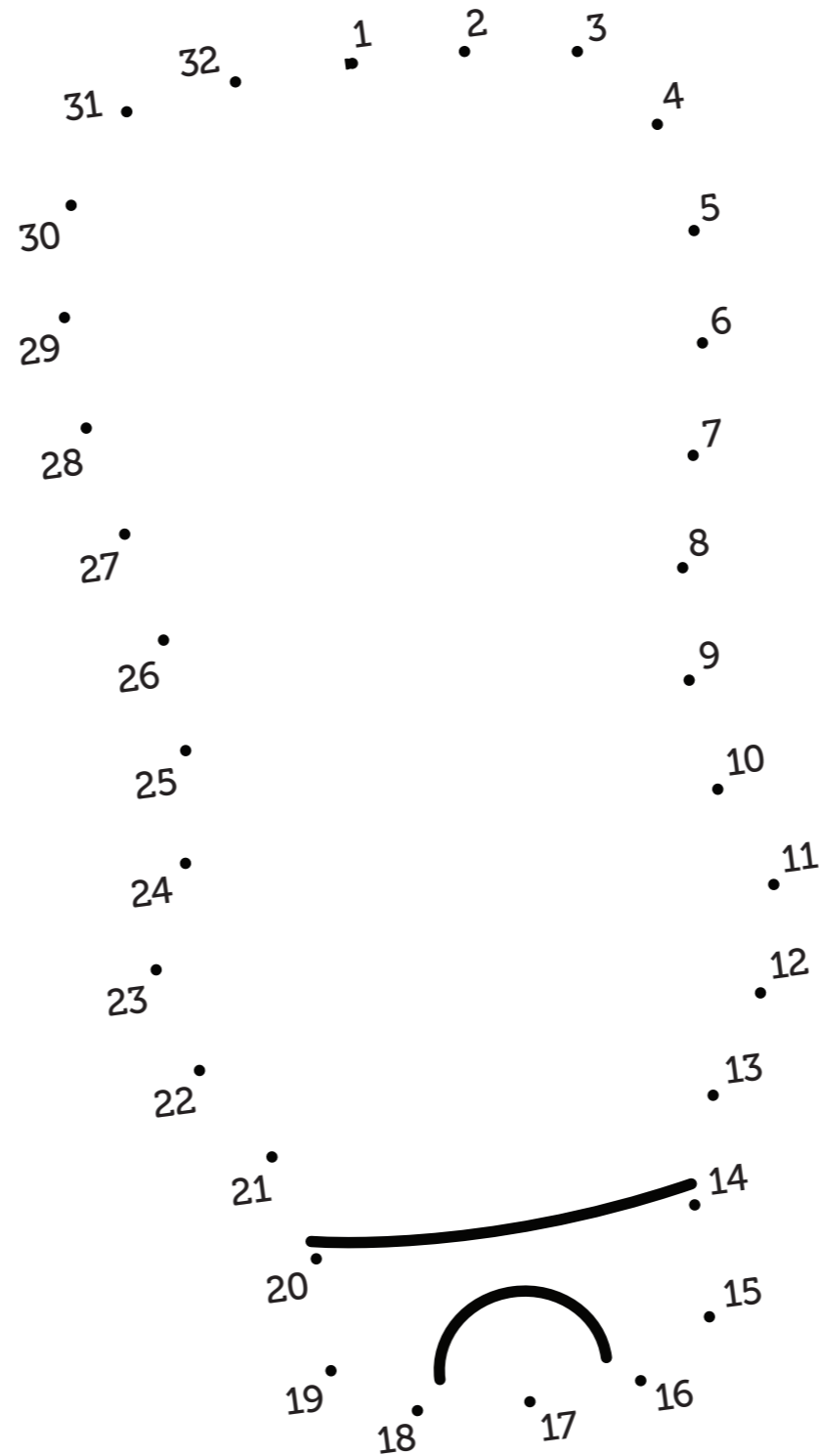
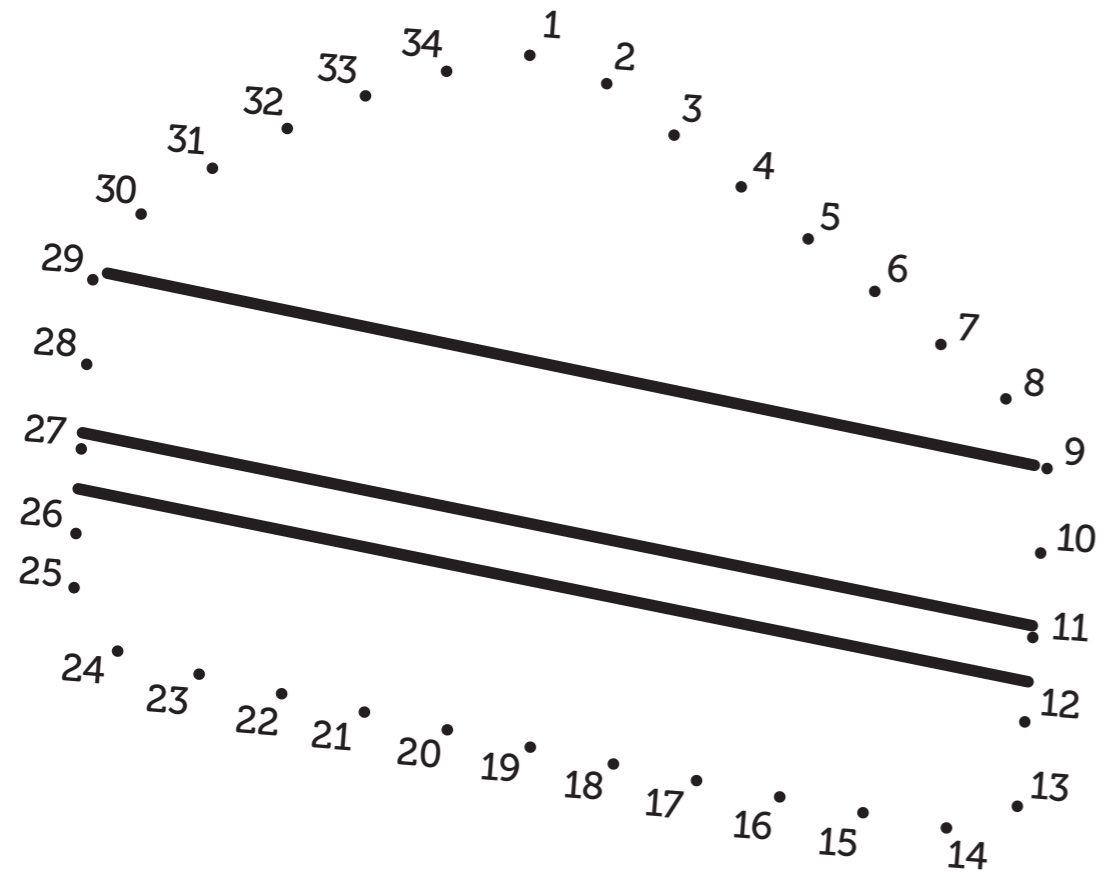

## DOT-TO-DOT

Connect the dots to reveal the different food or drinks.  
Are they a sugar hero (low sugar) or a sugar culprit (high sugar)? Colour in your finished images and write the name of each item underneath.

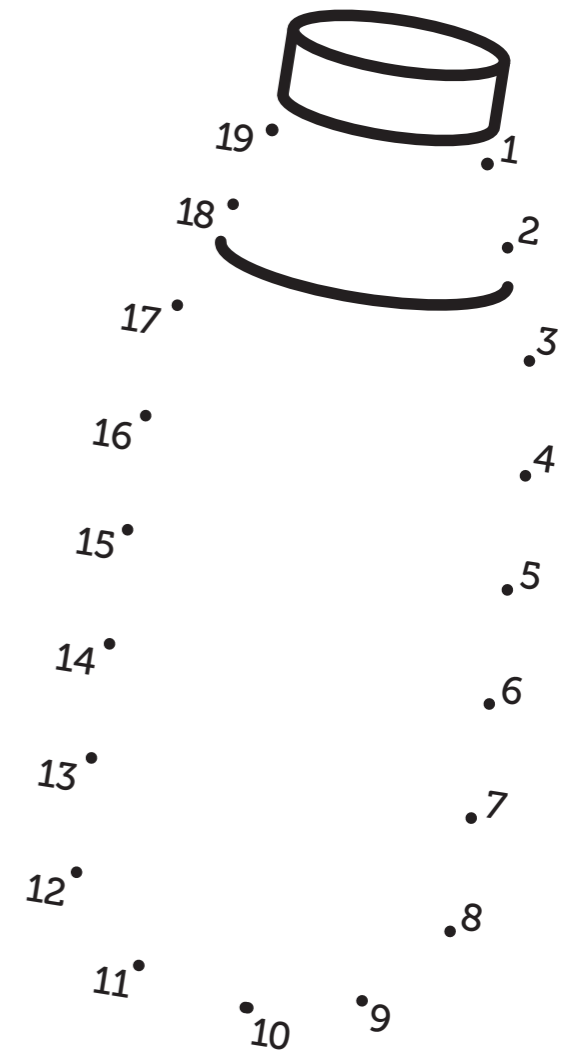
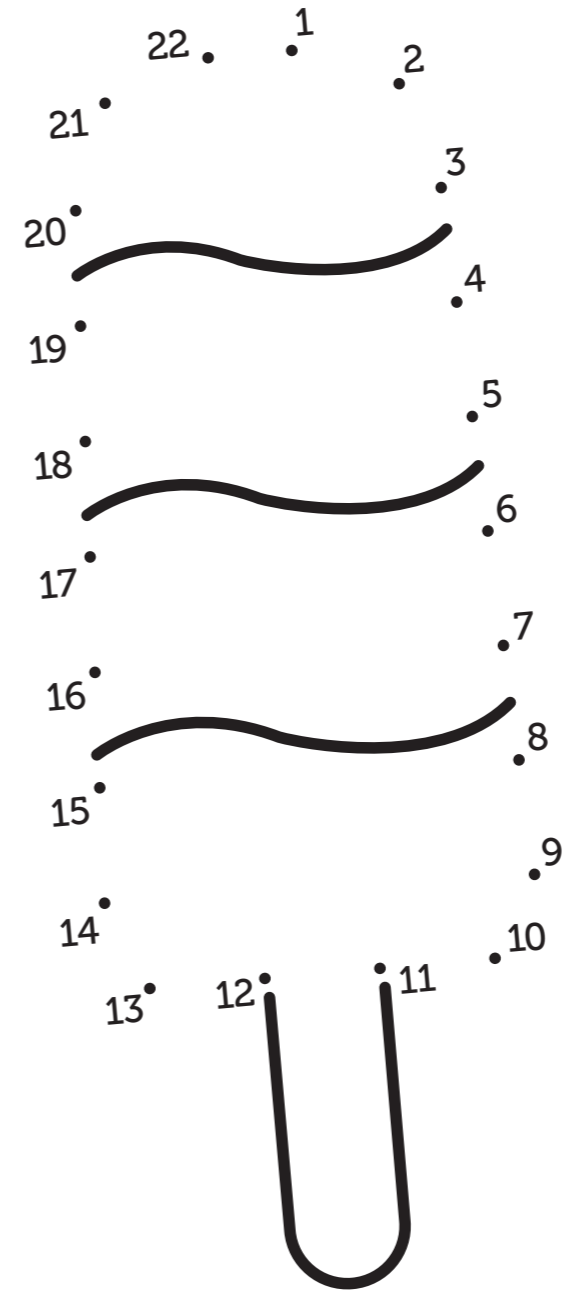
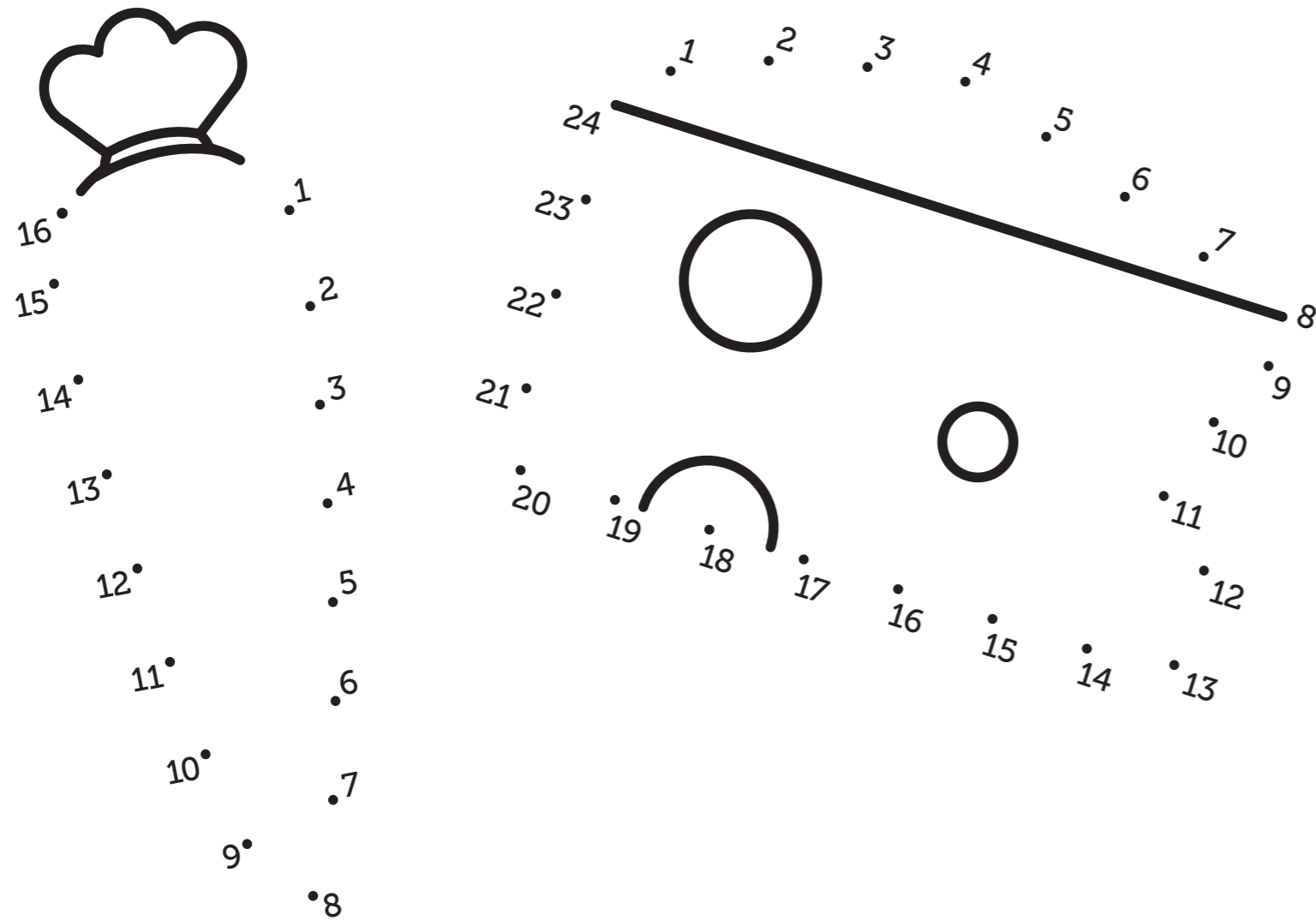

## WORDSEARCH

Hiding in this wordsearch are some types of foods and drinks. Can you find all of the sugar heroes (low sugar) and sugar culprits (high sugar)? Circle your answers.

- Pop
- Milk
- Sweets
- Pear
- Cake
- Apple
- Honey
- Sugar
- Juice
- Peas

A	A	A	P	C	A	O	P	H	R	S	R	P	E
E	A	E	E	P	U	R	E	W	C	P	E	Y	E
A	A	O	E	R	S	U	E	A	E	K	A	C	A
P	P	E	S	A	P	E	E	A	M	E	P	H	O
R	L	S	K	O	E	I	P	T	A	O	J	T	E
J	H	U	K	C	G	E	P	O	P	U	E	G	E
I	S	J	L	A	E	P	P	S	A	E	P	S	S
A	L	P	I	H	A	E	L	P	P	A	S	W	E
S	G	C	M	R	J	K	A	A	J	A	E	E	E
E	S	A	K	A	U	S	P	N	E	E	E	E	J
A	E	K	O	P	I	Y	E	P	T	K	I	P	H
W	W	S	E	E	C	P	O	S	I	P	C	E	C
E	S	H	O	N	E	Y	T	A	P	P	A	A	L
I	O	A	A	E	R	P	J	S	U	G	A	R	G



# Activity sheet for 7–10

## WORDSEARCH

Hiding in this wordsearch are some types of foods and drinks. Can you find all of the sugar heroes (low sugar) and sugar culprits (high sugar)? Circle your answers.

- |                                    |                                  |
|------------------------------------|----------------------------------|
| <input type="checkbox"/> Jam       | <input type="checkbox"/> Crumpet |
| <input type="checkbox"/> Dips      | <input type="checkbox"/> Bread   |
| <input type="checkbox"/> Cola      | <input type="checkbox"/> Cheese  |
| <input type="checkbox"/> Crackers  | <input type="checkbox"/> Water   |
| <input type="checkbox"/> Lemonade  | <input type="checkbox"/> Milk    |
| <input type="checkbox"/> Cereal    | <input type="checkbox"/> Grapes  |
| <input type="checkbox"/> Sweets    | <input type="checkbox"/> Snacks  |
| <input type="checkbox"/> Oranges   | <input type="checkbox"/> Yoghurt |
| <input type="checkbox"/> Chocolate | <input type="checkbox"/> Cake    |

D	A	B	N	I	S	E	P	A	R	G	K	S	G
D	O	R	A	N	G	E	S	T	E	D	R	S	C
L	L	C	W	C	R	C	E	R	E	A	L	E	H
E	S	M	R	A	K	N	C	U	C	A	K	E	O
M	E	S	I	A	T	A	R	H	U	K	A	R	C
O	J	A	S	L	C	E	H	G	P	B	W	C	O
N	E	A	G	A	K	K	R	O	E	R	W	O	L
A	A	A	M	A	E	M	E	Y	L	E	K	L	A
D	S	L	N	T	S	W	I	R	D	A	L	A	T
E	C	T	R	S	E	E	C	O	S	D	R	K	E
C	R	U	M	P	E	T	U	N	T	O	E	E	A
R	A	E	A	I	H	A	R	O	S	A	E	E	M
O	N	R	E	D	C	K	S	K	C	A	N	S	E
C	R	R	T	C	R	E	S	W	E	E	T	S	M

# HIDE AND SEEK



In this activity, we'll use the food and drinks you cut out and coloured in earlier. Ask a grown-up to hide them around the house then see how many you can find. The person with the most healthy snacks at the end WINS!

## LOW SUGAR BAKING

Why not make some of your favourite snacks a little healthier by swapping out ingredients? Here's a recipe that is fun and easy to make with your family. These oat bars are low in sugar, but still taste great!

### APPLE OAT BARS

#### Ingredients

- 2 cups of oats (1 cup quick cook and 1 cup rolled if possible)
- 1.5 tsp cinnamon
- 30g melted butter or coconut oil
- 1 up blitzed apples
- 1–2 tbsp honey (avoid for under 2s)

#### Instructions

1. In a medium bowl, mix the oats and cinnamon.
2. Add the melted butter and apple puree, mix to combine.
3. Line a baking tray (preferably a 20cm square cake tin).
4. Press the mix into the bottom of the baking dish so that it is an even layer. It should be around 1.5–2cm thick.
5. Bake at 180 for 25 mins. It should be firm to the touch, but not hard.
6. Cool and slice into squares.

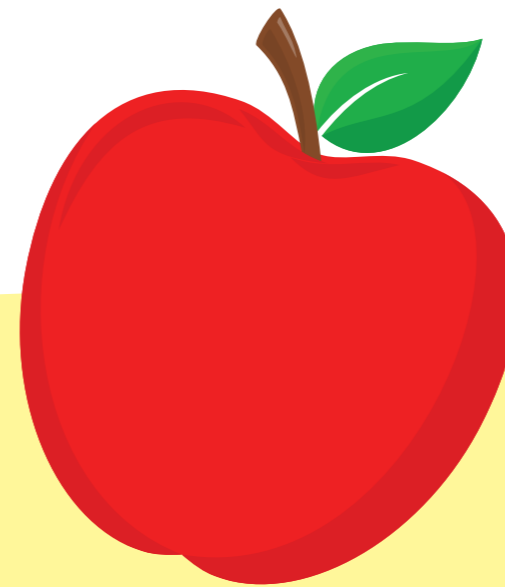

## LOW SUGAR BAKING

Why not make some of your favourite snacks a little healthier by swapping out ingredients? Here's a recipe that is fun and easy to make with your family. These brownies are sugar-free, but still taste great!

### SUGAR-FREE CHOCOLATE BROWNIES

#### Ingredients

- Oil, for greasing
- 200g/7oz self-raising flour
- 60g/13/4oz cocoa powder, sifted
- 1 tsp bicarbonate of soda
- 100g/3.5oz butter, cubed
- 100ml/3.5 fl oz semi-skimmed milk
- 3 large free range eggs, beaten
- 250g/9oz sweet potato, finely grated
- 1 large very ripe banana, mashed with a fork

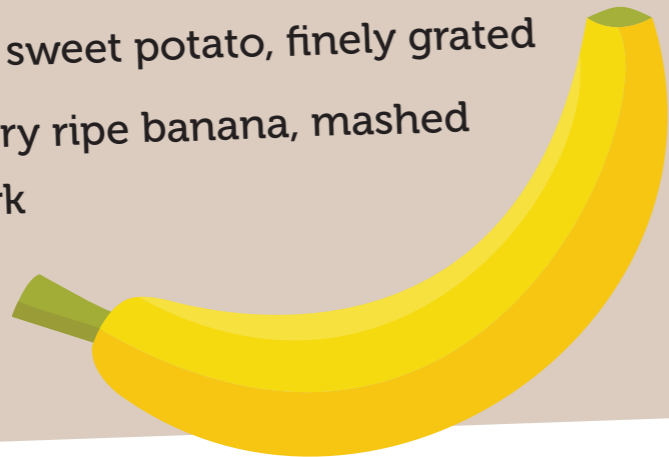

#### Instructions

1. Preheat the oven to 200c/180c Fan/Gas 6
2. Grease and line the base and sides of a 23cm/9in loose-based square cake tin with baking parchment.
3. Mix the flour, cocoa, bicarbonate of soda in a large bowl. Make a well in the centre.
4. Put the butter in a medium saucepan and melt over a low heat, stirring regularly.
5. Take the pan off the heat and stir the milk into the melted butter.
6. Add the eggs, sweet potato and banana, stirring vigorously.
7. Pour slowly into the flour mixture, stirring constantly with a wooden spoon to form a thick batter.
8. Pour into the prepared tin.
9. Bake in the centre of the oven for 30–35 minutes or until the cake is risen and just firm to the touch. Serve warm or leave to cool in the tin before cutting into squares.

